

This catalog illustrates the standard switch designs presently available. Included are circuit arrangements, electrical ratings, dimensions, mounting, termination and actuator options. This information is organized in a concise chart format to simplify the selection and ordering of the particular switches required.

Why Specify Electroswitch Switches?

Quality

Electroswitch switches are designed to meet the highest standards of quality and reliability, combining maximum performance characteristics with compact size.

Economy

Dependable design features, durability, competitive pricing and flexible delivery schedules serve to make Electroswitch switches your best buy.

Service

We cordially welcome all inquiries or questions regarding your switch requirements. Samples of standard catalog items can be furnished immediately upon request. Call or write Electroswitch for a prompt quotation.

UL FILE NO. E7407
CSA FILE NO. LR8435

2010 Yonkers Road, Raleigh, North Carolina 27604 USA
Phone: 888-768-2797 or 919-833-0707
Fax: 800-909-9171 or 919-833-8016
www.electro-nc.com
Email: sales@electro-nc.com

Toggle Switches

RATINGS	CIRCUIT	TOGGLE POSITION			CATALOG NUMBER			
					TYPE OF TERMINATION			
		UP	CENTER	DOWN (keyway)	.187 Q.C.	SCREW	.250 Q.C.	SOLDER LUG

7100 SERIES TOGGLE

RATINGS	CIRCUIT	TOGGLE POSITION			CATALOG NUMBER			
		UP	CENTER	DOWN (keyway)	.187 Q.C.	SCREW	.250 Q.C.	SOLDER LUG
6A-125VAC 3A-250VAC	SPST	ON	NONE	OFF	7105A	7105B	7105C	7105D
		(ON)	NONE	OFF	7135A	7135B	7135C	7135D
		ON	NONE	(OFF)	7145A	7145B	7145C	7145D
	SPDT	ON	NONE	ON	7101A	7101B	7101C	7101D
		ON	OFF	ON	7102A	7102B	7102C	7102D
		(ON)	NONE	ON	7151A	7151B	7151C	7151D
		(ON)	OFF	ON	7152A	7152B	7152C	7152D
		(ON)	OFF	(ON)	7162A	7162B	7162C	7162D

7000 SERIES TOGGLE

RATINGS	CIRCUIT	TOGGLE POSITION			CATALOG NUMBER			
		UP	CENTER	DOWN (keyway)	.187 Q.C.	SCREW	.250 Q.C.	SOLDER LUG
15A-125VAC 10A-250VAC	SPST	ON	NONE	OFF	7005A	7005B	7005C	7005D
		(ON)	NONE	OFF	7035A	7035B	7035C	7035D
		ON	NONE	(OFF)	7045A	7045B	7045C	7045D
	SPDT	ON	NONE	ON	7001A	7001B	7001C	7001D
		ON	OFF	ON	7002A	7002B	7002C	7002D
		(ON)	NONE	ON	7051A	7051B	7051C	7051D
		(ON)	OFF	ON	7052A	7052B	7052C	7052D
		(ON)	OFF	(ON)	7062A	7062B	7062C	7062D

7200 SERIES TOGGLE

RATINGS	CIRCUIT	TOGGLE POSITION			CATALOG NUMBER			
		UP	CENTER	DOWN (keyway)	.187 Q.C.	SCREW	.250 Q.C.	SOLDER LUG
20A-125VAC 10A-250VAC ¾ HP, 125-250VAC	SPST	ON	NONE	OFF	7205A	7205B	7205C	7205D
		(ON)	NONE	OFF	7235A	7235B	7235C	7235D
		ON	NONE	(OFF)	7245A	7245B	7245C	7245D
	SPDT	ON	NONE	ON	7201A	7201B	7201C	7201D
		ON	OFF	ON	7202A	7202B	7202C	7202D
		(ON)	NONE	ON	7251A	7251B	7251C	7251D
		(ON)	OFF	ON	7252A	7252B	7252C	7252D
		(ON)	OFF	(ON)	7262A	7262B	7262C	7262D

For .687 Toggle And .468 Bushing Length Add 100 To Part Number Specified
For Dust And Moisture Resistant Seal Add "S" To Part Number Specified*
*Standard Feature On Momentary Switches

() Denotes Momentary

SPECIFICATIONS

Agency Listings

 CSA Certified

Contact Mechanism

Slow-Make/Slow-Break Butt Contact

Contact Material

7100 Series:

Stationary - Copper Alloy/Silver Plated

Movable - Copper Alloy

7000 And 7200 Series:

Stationary (Center) - Copper Alloy/Silver Plated

Stationary (End) - Silver Cadmium Oxide Composite

Movable-Silver Cadmium Oxide Composite

Dielectric Strength

1000 Volts RMS Minimum

Mounting Means

15/32" Diameter Threaded Bushing

Keyway .078-.083 Wide X .037-.043 Deep

Standard Hardware Supplied —

One Hex Nut Assembled And

One Hex Nut Unassembled.

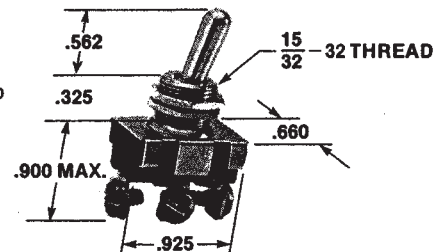

Toggle Switches

RATINGS	CIRCUIT	TOGGLE POSITION			CATALOG NUMBER			
					TYPE OF TERMINATION			
		UP	CENTER	DOWN (keyway)	.187 Q.C.	SCREW	.250 Q.C.	SOLDER LUG

9100 SERIES TOGGLE

6A-125VAC 3A-250VAC	DPST	ON	NONE	OFF	9103A	9103B	9103C	9103D
	DPDT	ON	NONE	ON	9101A	9101B	9101C	9101D
		ON	OFF	ON	9102A	9102B	9102C	9102D

9000 SERIES TOGGLE

15A-125VAC 10A-250VAC	DPST	ON	NONE	OFF	9003A	9003B	9003C	9003D
	DPDT	ON	NONE	ON	9001A	9001B	9001C	9001D
		ON	OFF	ON	9002A	9002B	9002C	9002D

9200 SERIES TOGGLE

20A-125VAC 10A-250VAC 3/4 HP, 125-250VAC	DPST	ON	NONE	OFF	9203A	9203B	9203C	9203D
	DPDT	ON	NONE	ON	9201A	9201B	9201C	9201D
		ON	OFF	ON	9202A	9202B	9202C	9202D

For .687 Toggle And .468 Bushing Length Add-100 To Part Number Specified
For Dust And Moisture Resistant Seal Add "S" To Part Number Specified

SPECIFICATIONS

Agency Listings



CSA Certified

Contact Mechanism

Slow-Make/Slow-Break Butt Contact

Contact Material

9100 Series:

Stationary - Copper Alloy/Silver Plated

Movable - Copper Alloy

9000 And 9200 Series:

Stationary (Center) - Copper Alloy/Silver Plated

Stationary (End) - Silver Cadmium Oxide Composite

Movable-Silver Cadmium Oxide Composite

Dielectric Strength

1000 Volts RMS Minimum

Mounting Means

15/32" Diameter Threaded Bushing

Keyway .078-.083 Wide X .037-.043 Deep

Standard Hardware Supplied —

One Hex Nut Assembled And

One Hex Nut Unassembled.

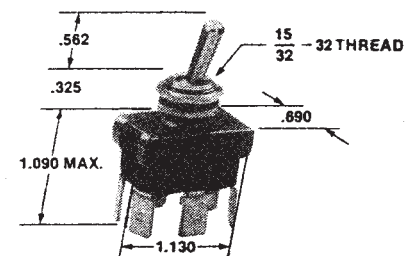

Toggle Switches

RATINGS	CIRCUIT	TOGGLE POSITION			CATALOG NUMBER			
		UP	CENTER	DOWN (keyway)	TYPE OF TERMINATION			
					.187 Q.C.	SCREW	.250 Q.C.	SOLDER LUG

7300 SERIES TOGGLE - SINGLE POLE

20A-125VAC 10A-250VAC 1 HP, 125-250VAC	SPST	ON	NONE	OFF	7305A	7305B	7305C	7305D
		(ON)	NONE	OFF	7335A	7335B	7335C	7335D
		ON	NONE	(OFF)	7345A	7345B	7345C	7345D
	SPDT	ON	NONE	ON	7301A	7301B	7301C	7301D
		ON	OFF	ON	7302A	7302B	7302C	7302D
		(ON)	NONE	ON	7351A	7351B	7351C	7351D
		(ON)	OFF	ON	7352A	7352B	7352C	7352D
		(ON)	OFF	(ON)	7362A	7362B	7362C	7362D

9300 SERIES TOGGLE - DOUBLE POLE

20A-125VAC 10A-250VAC 1 HP, 125-250VAC	DPST	ON	NONE	OFF	9303A	9303B	9303C	9303D
	DPDT	ON	NONE	ON	9301A	9301B	9301C	9301D
		ON	OFF	ON	9302A	9302B	9302C	9302D

For .687 Toggle And .468 Bushing Length Add-100 To Part Number Specified
For Dust And Moisture Resistant Seal Add "S" To Part Number Specified
*Standard Feature On Momentary Switches

() Denotes Momentary

SPECIFICATIONS

Agency Listings



CSA Certified

Contact Mechanism

Slow-Make/Slow-Break Butt Contact

Contact Material

Stationary (Center) - Copper Alloy/Silver Plated
Stationary (End) - Silver Cadmium Oxide Composite
Movable-Silver Cadmium Oxide Composite

Dielectric Strength

1500 Volts RMS Minimum

Mounting Means

15/32" Diameter Threaded Bushing
Keyway .078-.083 Wide X .037-.043 Deep
Standard Hardware Supplied —
One Hex Nut Assembled And
One Hex Nut Unassembled.

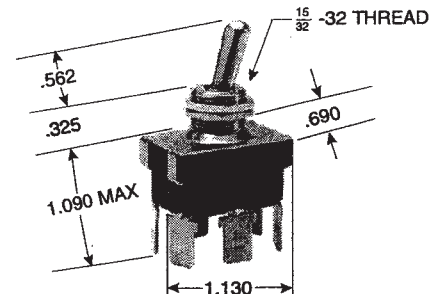
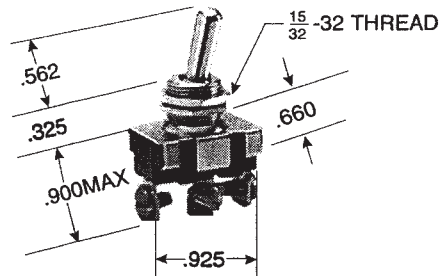

UL FILE NO. E7407
CSA FILE NO. LR8435

Toggle Switches - D.C. Rated

RATINGS	CIRCUIT	TOGGLE POSITION			CATALOG NUMBER			
		UP	CENTER	DOWN (keyway)	TYPE OF TERMINATION			
					.187 Q.C.	SCREW	.250 Q.C.	SOLDER LUG

7600 SERIES TOGGLE - SINGLE POLE

5A-30V	SPST	ON	NONE	OFF	7605A	7605B	7605C	7605D
		(ON)	NONE	OFF	7635A	7635B	7635C	7635D
		ON	NONE	(OFF)	7645A	7645B	7645C	7645D
	SPDT	ON	NONE	ON	7601A	7601B	7601C	7601D
		ON	OFF	ON	7602A	7602B	7602C	7602D
		(ON)	NONE	ON	7651A	7651B	7651C	7651D
		(ON)	OFF	ON	7652A	7652B	7652C	7652D
		(ON)	OFF	(ON)	7662A	7662B	7662C	7662D

9600 SERIES TOGGLE - DOUBLE POLE

5A-30V	DPST	ON	NONE	OFF	9603A	9603B	9603C	9603D
	DPDT	ON	NONE	ON	9601A	9601B	9601C	9601D
		ON	OFF	ON	9602A	9602B	9602C	9602D

For .687 Toggle And .468 Bushing Length Add 100 To Part Number Specified
For Dust And Moisture Resistant Seal Add "S" To Part Number Specified

SPECIFICATIONS

Contact Mechanism

Slow-Make/Slow-Break Butt Contact

Contact Material

Stationary - Copper Alloy/Silver Plated
Movable - Copper Alloy/ Silver Plated

Mounting Means

15/32" Diameter Threaded Bushing
Keyway .078-.083 Wide X .037-.043 Deep
Standard Hardware Supplied-
One Hex Nut Assembled And
One Hex Nut Unassembled.

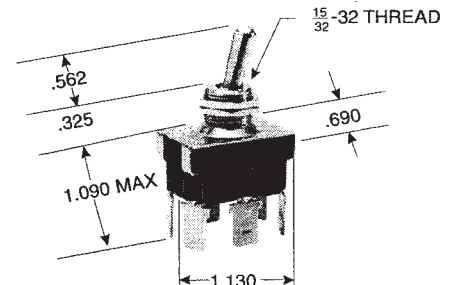
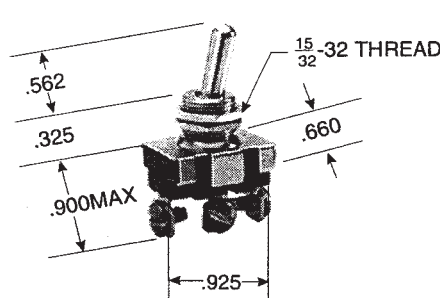

Special Application - SHORTING SWITCH

CATALOG NUMBER			
TYPE OF TERMINATION			
.187 Q.C.	SCREW	.250 Q.C.	SOLDER LUG

7705A	7705B	7705C	7705D
-------	-------	-------	-------

KEYWAY OPPOSITE TERMINAL

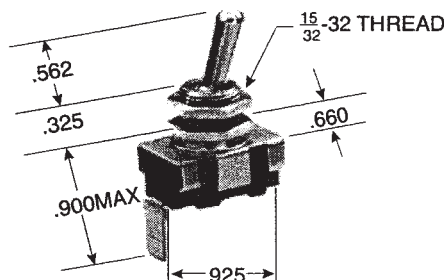

Wire Lead Toggle & Push Button Switches

RATINGS	CIRCUIT	ACTION	TOGGLE		BUSHING LENGTH	CATALOG NUMBER	TYPE OF TERMINATION	ACTUATOR MATERIAL
			TYPE	LENGTH				

6600 SERIES TOGGLE

Optional Lead Lengths Available Upon Request

10A-125VAC 8A-125V 4A-250V 1/3 HP, 125VAC	SPST	OFF-ON	BAT	.562	.325	6600	6" WIRE LEADS 1/2" STRIPPING #18 GAUGE	NICKEL PLATED BRASS
			BAT	.812	.325	6601		
			BAT	.687	.468	6601-100		
			BALL	.375	.325	6602		PLASTIC
			BAT	.562	.325	6603		
12A-125VAC 8A-125V 4A-250V 1/3 HP, 125VAC	SPST	OFF-ON	BAT	.562	.325	6630	6" WIRE LEADS 1/2" STRIPPING #16 GAUGE	NICKEL PLATED BRASS
			BAT	.812	.325	6631		
			BAT	.687	.468	6631-100		
			BALL	.375	.325	6632		
15A-125VAC 1/2 HP, 125VAC	SPST	OFF-ON	BAT	.562	.325	6606	6" WIRE LEADS 1/2" STRIPPING #16 GAUGE	NICKEL PLATED BRASS
			BAT	.812	.325	6607		
			BAT	.687	.468	6607-100		
			BALL	.375	.325	6608		

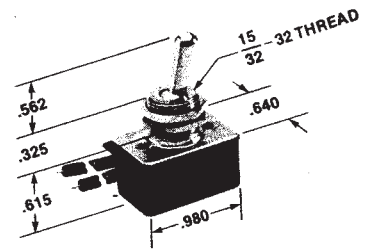

RATINGS	CIRCUIT	ACTION	ACTUATOR	CATALOG NUMBER	TYPE OF TERMINATION
---------	---------	--------	----------	----------------	---------------------

6611 & 6612 SERIES PUSHBUTTON

Optional Lead Lengths Available Upon Request

10A-125VAC 8A-125V 4A-250V 1/3HP-125VAC	SPST	PUSH ON/PUSH OFF	METAL PLUNGER	6611	6" WIRE LEADS 1/2" STRIPPING #18 GAUGE
			METAL LOW PROFILE	6611-LP	
			NYLON PLUNGER	6612	
12A-125VAC 8A-125V 4A-250V 1/3HP-125VAC	SPST	PUSH ON/PUSH OFF	METAL PLUNGER	6641	6" WIRE LEADS 1/2" STRIPPING #16 GAUGE
			METAL LOW PROFILE	6641-LP	
			NYLON PLUNGER	6642	
15A-125VAC 1/2HP-125VAC	SPST	PUSH ON/PUSH OFF	METAL PLUNGER	6616	6" WIRE LEADS 1/2" STRIPPING #16 GAUGE
			METAL LOW PROFILE	6616-LP	
			NYLON PLUNGER	6617	

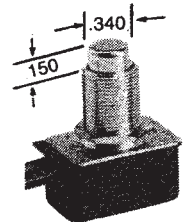

6 SERIES L.P.

SPECIFICATIONS

Agency Listings

CSA Certified

Contact Mechanism

Quick-Make/Quick-Break Wiping Action

Contact Material

6600-6632 Series: Copper Alloy

6611-6642 Series: Copper Alloy

6606-6608 Series:

6616-6617 Series:

Stationary - Copper Alloy With Silver Cadmium Oxide Inlay

Movable - Copper Alloy/Silver Plated

Dielectric Strength

1000 Volts RMS Minimum

Mounting Means

15/32" Diameter Threaded Bushing

Keyway .078-.083 Wide X .037-.043 Deep

Standard Hardware Supplied —

One Hex Nut Assembled And

One Hex Nut Unassembled

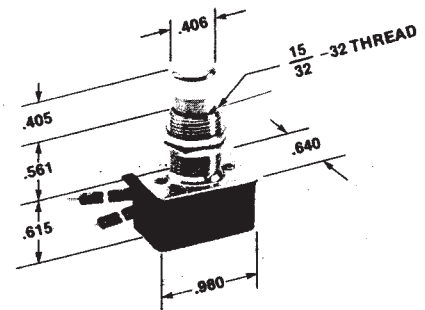

Push Button Switches

RATINGS	CIRCUIT	ACTION	CATALOG NUMBER			
			TYPE OF TERMINATION			
			.187 Q.C.	SCREW	.250 Q.C.	SOLDER LUG

7100 SERIES PUSHBUTTON

6A-125VAC 3A-250VAC	SPST	PUSH ON	PUSH OFF	7104A	7104B	7104C	7104D
		OFF	(ON)	7174A	7174B	7174C	7174D
		ON	(OFF)	7184A	7184B	7184C	7184D
	SPDT	PUSH ON	PUSH ON	7103A	7103B	7103C	7103D
		ON	(ON)	7173A	7173B	7173C	7173D

7000 SERIES PUSHBUTTON

15A-125VAC 10A-250VAC	SPST	PUSH ON	PUSH OFF	7004A	7004B	7004C	7004D
		OFF	(ON)	7074A	7074B	7074C	7074D
		ON	(OFF)	7084A	7084B	7084C	7084D
	SPDT	PUSH ON	PUSH ON	7003A	7003B	7003C	7003D
		ON	(ON)	7073A	7073B	7073C	7073D

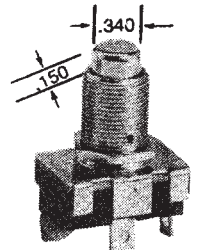

7 SERIES L.P.

() Denotes Momentary

Specify Metal Or Nylon Actuator
To Obtain Metal Low Profile Actuation Add L.P. To P/N.

SPECIFICATIONS

Agency Listings

 CSA Certified

Contact Mechanism

Slow-Make/Slow-Break Butt Contact

Contact Material

7100 Series:
Stationary-Copper Alloy/Silver Plated
Movable-Copper Alloy

7000 Series:
Stationary (Center)-Copper Alloy/Silver Plated
Stationary (End)-Silver Cadmium Oxide Composite
Movable-Silver Cadmium Oxide Composite

Dielectric Strength

1000 Volts RMS Minimum

Mounting Means

15/32" Diameter Threaded Bushing
Keyway .080-.083 Wide X .032-.038 Deep
Standard Hardware Supplied —
One Hex Nut Assembled And
One Hex Nut Unassembled

Switch Hardware



#42-06 Hex Nut #42-04 Knurled Nut #34-08 Lockwasher #52-08 ON-OFF Plate #52-30 HI-LO Plate #34-13 Locking Ring

CATALOG NUMBER	DESCRIPTION	SPECIFICATIONS	FINISH
42-06	HEX NUT	.562 O.D., .074 THICK	NICKEL
42-04	KNURLED NUT	.605 O.D., .100 THICK	NICKEL
34-08	LOCKWASHER	.600 O.D., .018 THICK	NICKEL
52-08	ON-OFF PLATE	.025 THICK	NICKEL
52-30	HI-LO PLATE	.025 THICK	NICKEL
34-13	LOCKING RING	.718 O.D., .040 THICK	ZINC

All Of The Above Hardware Fits A 15/32-32 Bushing