

FIGURES/CIRCUIT DIAGRAMS

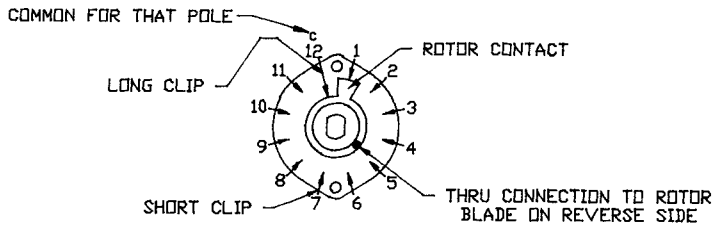

ALL DIAGRAMS ARE DRAWN AS VIEWED FROM THE KNOB END OF THE SWITCH, WITH THE LOCATING LUG IN THE 9 O'CLOCK POSITION AND THE SHAFT IN THE EXTREME COUNTER CLOCKWISE POSITION.

THE 'REAR' SIDE DIAGRAM OF THE SECTION IS VIEWED AS TRANSPARENT FROM THE KNOB END.

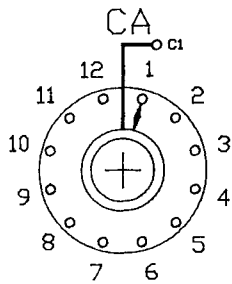

ONE POLE
2-12 POSITION

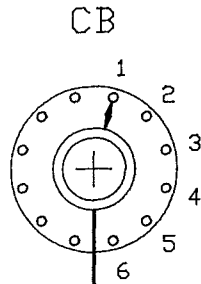

ONE POLE
2-6 POSITION
VPC

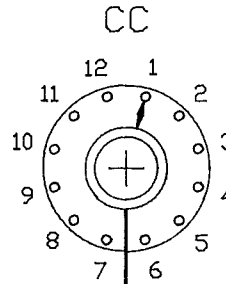

ONE POLE
2-12 POSITION
VPC

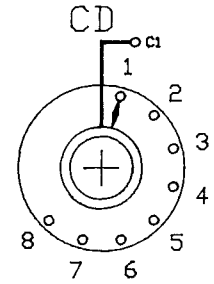

ONE POLE
2-8 POSITION

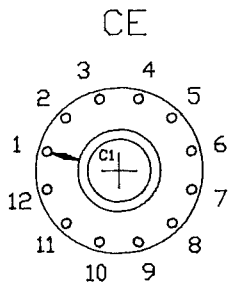

ONE POLE
2-12 POSITION

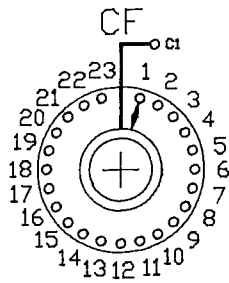

ONE POLE
2-23 POSITION

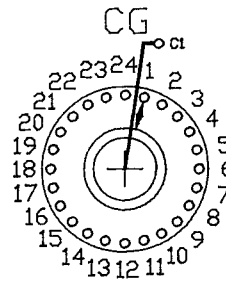

ONE POLE
24 CONTINUOUS

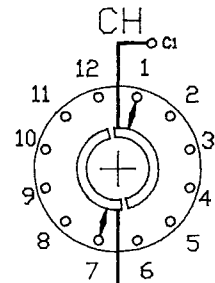

TWO POLE
2-6 POSITION

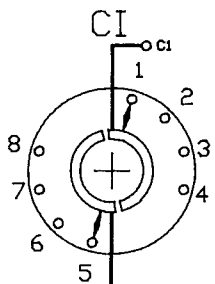

TWO POLE
2-4 POSITION

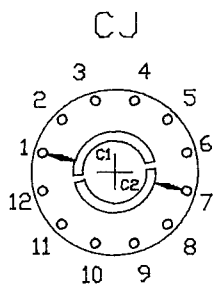

TWO POLE
2-6 POSITION

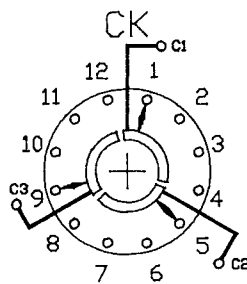

THREE POLE
2-4 POSITION

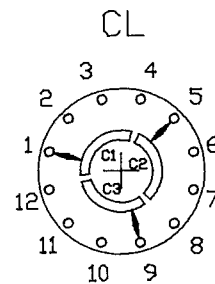

THREE POLE
2-4 POSITION

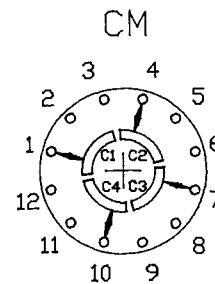

FOUR POLE
2-3 POSITION

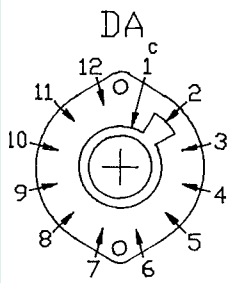

REAR
ONE POLE
2-11 POSITION

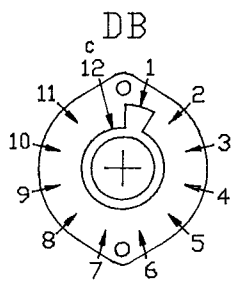

REAR
ONE POLE
2-11 POSITION

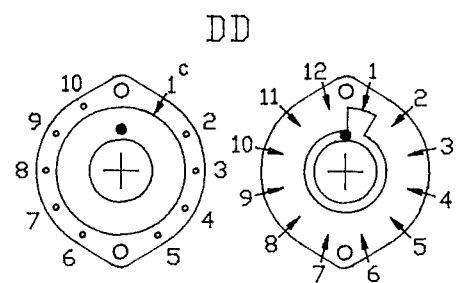

FRONT
REAR
ONE POLE, 2-12 POSITION

FIGURES/CIRCUIT DIAGRAMS

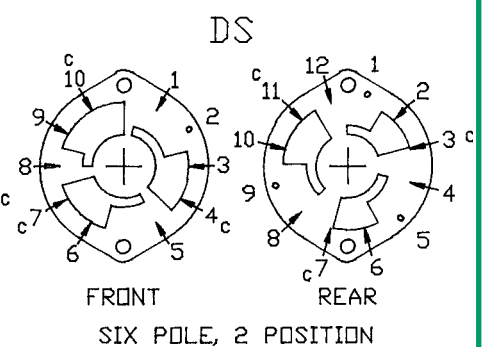
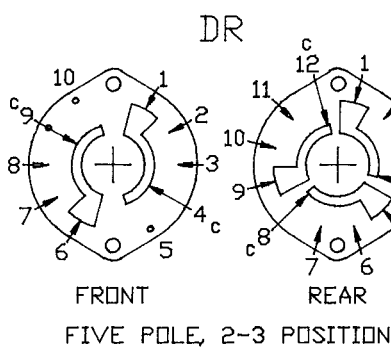
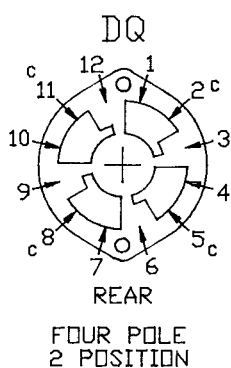
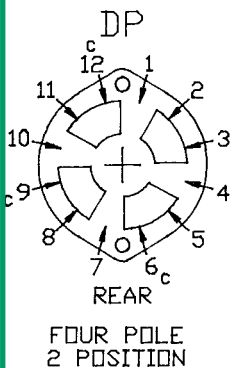
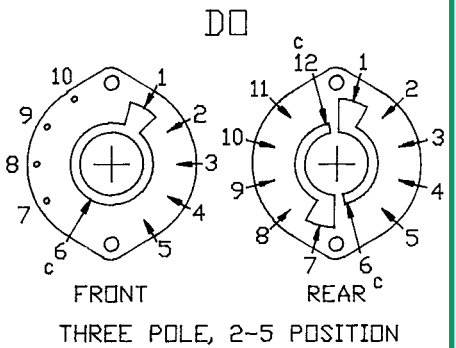
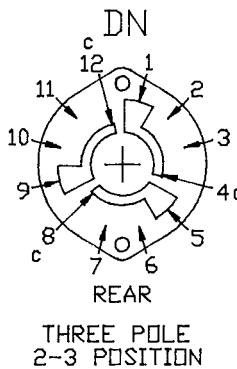
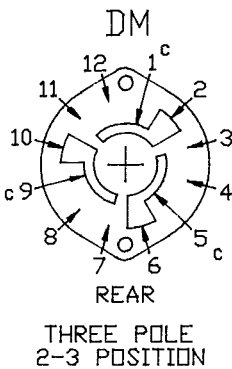
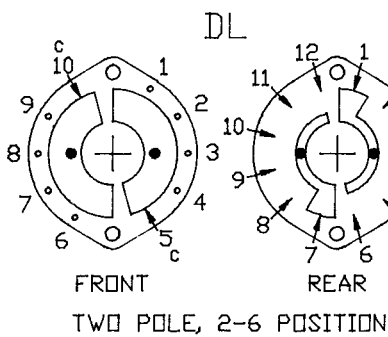
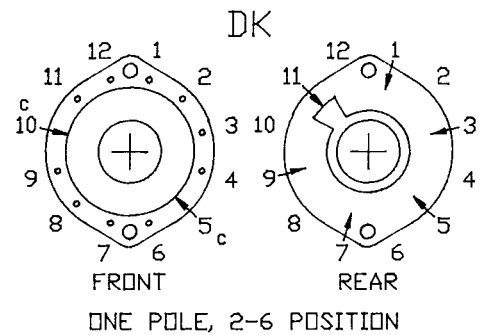
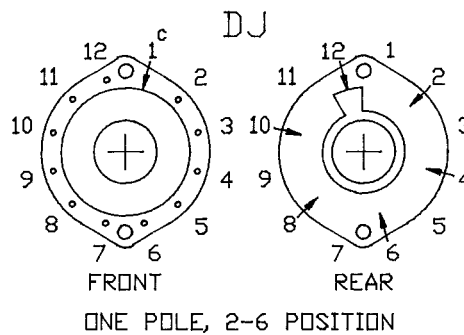
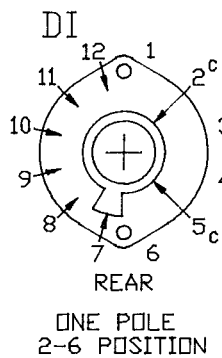
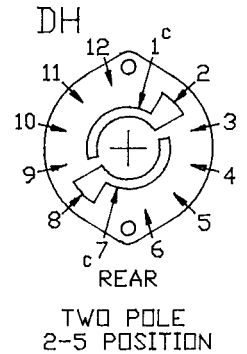
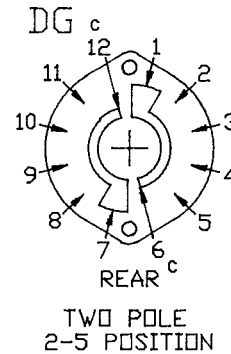
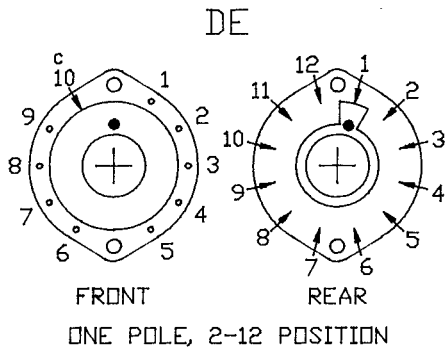

VIEWED FROM THE KNOB END OF SWITCH